

GM-1000

9th/8th Gen Intel® Xeon®/Core™ Embedded GPU Computer,
Supports 1x MXM 3.1 GPU Expansion Socket



- Supports 9th/8th Gen Intel® Xeon®/Core™ Processor up to 8 cores
- Supports 1x MXM 3.1 Type A/B form factor GPU module expansion
- 2x DDR4 SO-DIMM sockets, up to 2666MHz, 64GB
- Supports wide operating temperature (-40°C - 70°C) and vibration/shock tolerance (5G/50G)
- 260 mm x 200 mm x 85 mm compact footprint
- Flexible functionality expansions:
 - M.2 E key (CNVi), full-size Mini-PCIe and M.2 M Key (NVMe SSD)
 - Proprietary CMI interface for various I/O expandability
 - Proprietary CFM interface for PoE+ or Power Ignition Sensing



Overview

The GM-1000 is a rugged GPU computing platform supporting embedded MXM GPU expansion. It has all the features required for a compact, reliable, and high-performance computing system for field applications in machine vision, image processing, and artificial intelligence.

Based on the latest Intel® Coffee Lake-R platform, GM-1000 is able to equip with 9th/8th generation workstation grade processor up to 8 cores and dual DDR4-2666 SO-DIMM memory up to 64 GB, that can deliver outstanding computing performance for high-end applications.

The compact GPU system, sized at 260 mm x 200 mm x 85 mm, can accommodate 1 x standard MXM 3.1 Type A/B form factor GPU module slot. It allows GPU-accelerated technology from NVIDIA® or AMD® to speed up intensive workloads by executing massive parallel processing, delivering an optimized performance for demanding embedded vision computing applications.

The unique thermal design is adopted for GM-1000 to maximize the heat dissipation efficiency and allows GM-1000 to thrive in extreme environmental conditions. The thermal solution is made possible with the design of industrial grade components, copper heat pipes, a special aluminum extrusion case, and an optional external fan. This thermal design provides effective heat dissipation and allows high performance GPU applications with reliability.

Moreover, the GM-1000 supports extra functionality and I/O expansions. Thru Cincoze's innovative CMI / CFM (Combined Multiple IO / Control Function Module) technologies, the GM-1000 can be extended with PoE, power ignition sensing, and various I/Os such as LAN, M12, DIO, USB, and COM. The technologies provide a customized expansion to fulfill each user's specific needs and applications.

Highlights



Superb Performance

The GM-1000 supports the latest 9th-gen Intel® Xeon® E-series / Core processors (up to 8-core). The computing engine supports remarkable features such as Turbo Boost and Hyper-Threading technology and offers a significant improvement in performance.



Embedded GPU Expansion

GM-1000 supports MXM 3.1 socket Type A/B module expansion from NVIDIA® / AMD®. To protect the user's investment, GM-1000 is designed with an outstanding system architecture that allows for future upgradability of the MXM module.



Unique Thermal Design

The GM-1000 features an unique and effective thermal design for maximum heat dissipation efficiency that offers stability to the system during GPU-based operation for the field.

Specifications

Processor

- 9th Generation Intel® Coffee Lake-R CPU:
 - Intel® Xeon® E-2278GE 8 Cores Up to 4.7 GHz, TDP 80W
 - Intel® Xeon® E-2278GEL 8 Cores Up to 3.9 GHz, TDP 35W
 - Intel® Core™ i7-9700E 8 Cores Up to 4.4 GHz, TDP 65W
 - Intel® Core™ i5-9500E 6 Cores Up to 4.2 GHz, TDP 65W
 - Intel® Core™ i3-9100E 4 Cores Up to 3.7 GHz, TDP 65W
 - Intel® Core™ i7-9700TE 8 Cores Up to 3.8 GHz, TDP 35W
 - Intel® Core™ i5-9500TE 6 Cores Up to 3.6 GHz, TDP 35W
 - Intel® Core™ i3-9100TE 4 Cores Up to 3.2 GHz, TDP 35W
- 8th Generation Intel® Coffee Lake CPU:
 - Intel® Xeon® E-2176G 6 Cores up to 4.7 GHz, TDP 80W
 - Intel® Xeon® E-2124G 4 Cores up to 4.5 GHz, TDP 71W
 - Intel® Core™ i7-8700 6 Cores up to 4.6 GHz, TDP 65W
 - Intel® Core™ i5-8500 6 Cores, up to 4.1 GHz, TDP 65W
 - Intel® Core™ i3-8100 4 Cores 3.6 GHz, TDP 65W
 - Intel® Core™ i7-8700T 6 Cores up to 4.0 GHz, TDP 35W
 - Intel® Core™ i5-8500T 6 Cores up to 3.5 GHz, TDP 35W
 - Intel® Core™ i3-8100T 4 Cores 3.1 GHz, TDP 35W
 - Intel® Pentium® G5400 2 Cores 3.7 GHz, TDP 58W
 - Intel® Pentium® G5400T 2 Cores 3.1 GHz, TDP 35W
 - Intel® Celeron® G4900 2 Cores 3.1 GHz, TDP 54W
 - Intel® Celeron® G4900T 2 Cores 2.9 GHz, TDP 35W

Chipset

- Intel® C246

BIOS

- AMI BIOS

Memory

- 2x DDR4-2666/2400 MHz SO-DIMM Sockets
- Support up to 64 GB (Un-buffered and non-ECC type)
 - * Xeon/i7/i5: Up to DDR4 2666MHz
 - * i3/Pentium/Celeron: Up to DDR4 2400MHz

Graphics

- Integrated Intel® UHD Graphics
(Xeon/i7/i5/i3: UHD 630; Pentium/Celeron: UHD 610)
- Supports Triple Independent Display (DVI-I/DisplayPort/HDMI)

Audio Codec

- Realtek® ALC888, High Definition Audio

I/O Interface

- 1x DVI-I Connector (VGA: 1920 x1080 @ 60 Hz; DVI-D: 1920 x1200 @ 60 Hz)
- 1x DisplayPort Connector (4096 x 2304 @ 60Hz)
- 1x HDMI Connector (4096 x 2160 @ 30Hz)
- 2x GbE LAN Ports (Supports WoL, Teaming, Jumbo Frame & PXE), RJ45
 - GbE1: Intel® I219-LM
 - GbE2: Intel® I210-IT
- 4x RS-232/422/485 Ports with Auto Flow Control (Support 5V/12V), DB9
- 4x 10Gbps USB3.2 Gen2 Ports, Type-A
- 4x 5Gbps USB3.2 Gen1 Ports, Type-A
- 1x Line-out & 1x Mic-in, Phone Jack 3.5mm
- 1x ATX Power On/Off Button
- 1x Reset Button

- 1x AT/ATX Mode Switch
- 1x Clear CMOS Switch
- 1x Remote Power On/Off Connector, 2-pin Terminal Block
- 2x External Fan Connectors, 4-pin Terminal Block
(Supports Smart Fan by BIOS)

Storage

- 2x SATA III (6Gbps) Front Accessible 2.5" HDD/SSD Trays
(up to 15mm in Height)
- 3x mSATA Sockets (Shared by Mini-PCIe Socket)
- Supports S/W RAID 0, 1, 5 & 10
- 1x PCIe x4 M.2 Key M 2280 Socket, Supports NVMe SSD

Expansion

- CMI (Combine Multiple I/O) Interface
 - 1x High Speed CMI Interface for I/O Expansion
 - CMI-10GLAN01 : 2x 10G Intel® X550 RJ45 LAN
 - CMI-LAN01 : 4x 1G Intel® I210-IT RJ45 LAN
 - CMI-M12LAN01 : 4x 1G Intel® I210-IT M12 LAN
 - 1x Low Speed CMI Interface
 - CMI-COM01 : 2x RS232/422/485, Support 5V/12V
 - CMI-DIO01 : 16x DIO (8 in, 8 out)
- 1x CFM IGN Interface
 - CFM-IGN01: Ignition Sensing Function
- 1x MXM Carrier Board Interface for MXM GPU Module Expansion
- 1 x PCIe x2 M.2 Key E 2230 socket, support Intel CNVi Module
- 3x Full-size Mini-PCIe Sockets
- 2x SIM Sockets
- 2x Antenna Holes

Other Function

- Instant Reboot: Support 0.2 sec. Instant Reboot Technology
- SuperCap Integrated for CMOS Battery Maintenance-free Operation
- Watchdog Timer: Software Programmable Supports 256 Levels System Reset

Power Requirement

- Supports AT/ATX Power Type
- Total Power Budget: 360W
- Power Input Voltage: 9-48 VDC, Single Power Source
- Connector Type: 2x 3-pin Terminal Block, Each Terminal Block Current Limitation is 15A
- Power input voltage from 9V to 23V must use dual power connectors, power input voltage from 24V to 48V can use single power connector
- Power Adaptor
 - Optional AC/DC 24V Power Adapter, 220W

Physical

- Dimension (WxDxH): 260 x 200 x 85 mm
- Weight: 4.6 kg
- Extruded Aluminum with Heavy Duty Metal
- Wall Mount/VESA Mount/DIN Rail/Side Mount
- Unibody Chassis
- Fanless Design
- Jumper-less Design
- Cable-less Design

Protection

- Reverse Power Input Protection
- Over Voltage Protection
 - Protection Range: 51~58V
 - Protection Type: shut down operating voltage, re-power on at the preset level to recover
- Over Current Protection: 30A
- ESD Protection: +/-8kV (air), +/-4kV (contact)
- Surge Protection: 3.84 kV (Impedance 12 ohm 1.2/50us Waveform)

Operating System

- Windows® 10
- Linux: Supports by Project

Environment

- Operating Temperature:

CPU	with FAN module	Operating Temp.
35W	-	-40°C - 70°C
65W	V	-40°C - 60°C
80W	V	-40°C - 55°C

- * PassMark BurnInTest: 100% CPU, 2D Graphics (without thermal throttling)
- * For GM-1000 + MXM GPU Module operating temperature, please refer to the last page – **Operating Temperature Matrix Table** for more information
- * With extended temperature peripherals; Ambient with air flow
- * According to IEC60068-2-1, IEC60068-2-2, IEC60068-2-14
- Storage Temperature: -40°C to 85°C
- Relative Humidity: 95% RH @ 70°C (Non-condensing)
- Shock: Operating, 50 Grms, Half-sine 11 ms Duration
 - * w/ SSD, according to IEC60068-2-27
- Vibration: Operating, 5 Grms, 5-500 Hz, 3 Axes
 - * w/ SSD, according to IEC60068-2-64
- MTBF: 331,596 Hours
Database: Telcordia SR-332 Issue 3, Method 1, Case 3

Certification

- EMC: CE/FCC Class A, EN 50121-3-2, E-mark (E13 No. 10R-0615566)
- Safety: LVD (EN62368-1)

External Layout

Front I/O

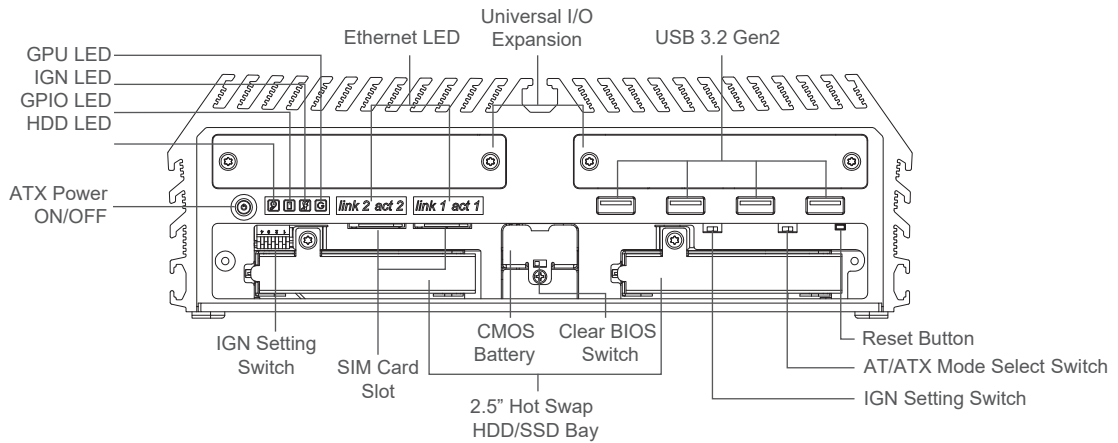

Rear I/O

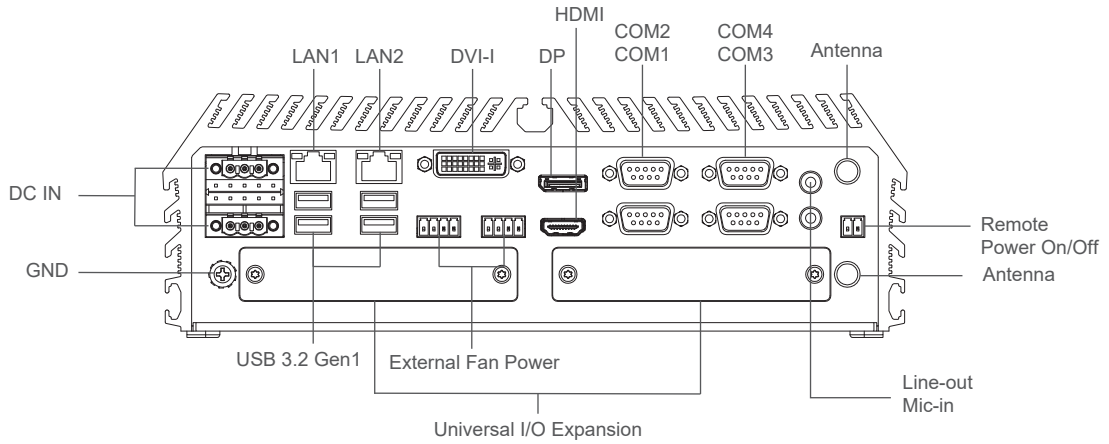

Dimensions

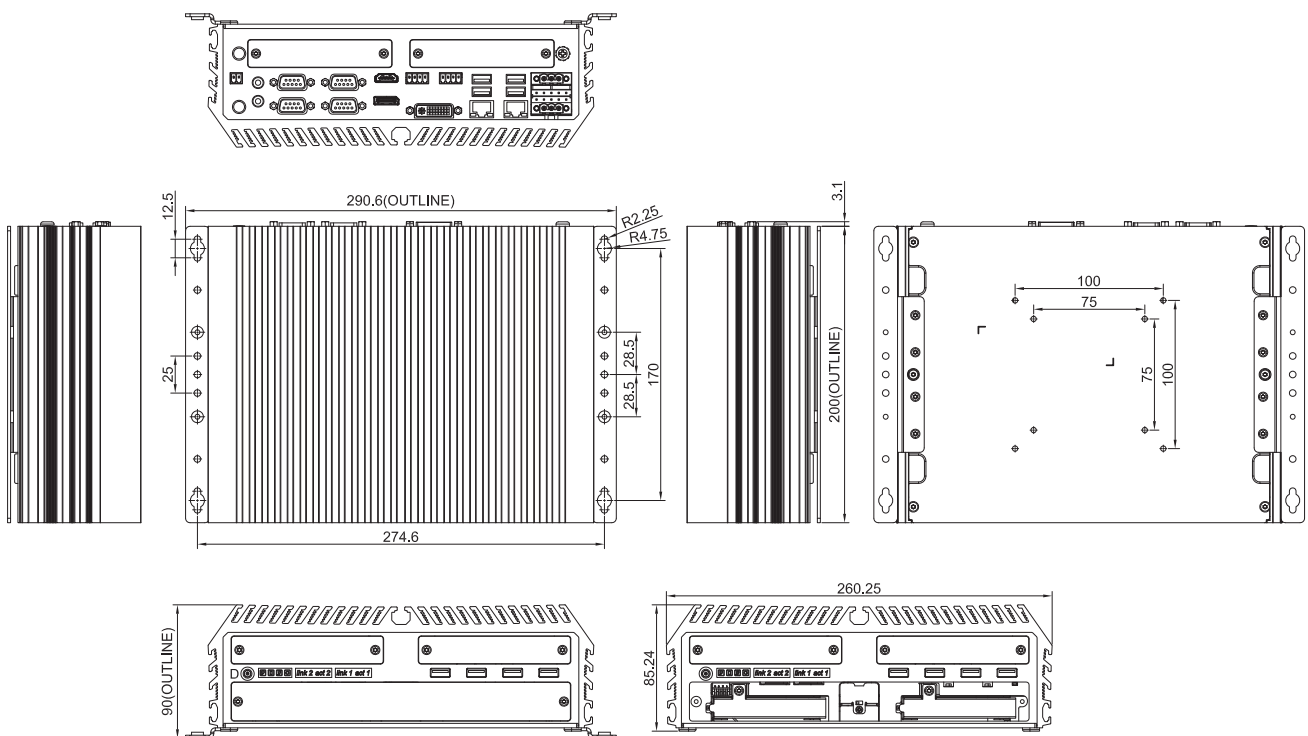

Unit: mm

Ordering Information

Available Models

Model No.	Description
GM-1000-R10	9th/8th Gen Intel® Xeon®/Core™ Embedded GPU Computer, Supports 1x MXM 3.1 GPU Expansion Socket

Package Checklist

- GM-1000 GPU Computer x 1
- Utility DVD Driver x 1
- CPU Heat Sink and Thermal Pad x 1
- Screw Pack x 1
- Power Terminal Block Connector x 2
- Remote Power On/Off Terminal Block Connector x 1
- Fan Terminal Block Connector x 2
- DVI-I to VGA Adaptor
- Wall Mount Kit x1

Optional MXM GPU Module







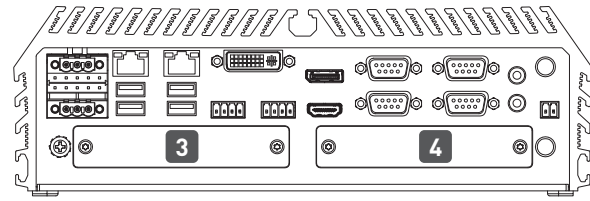
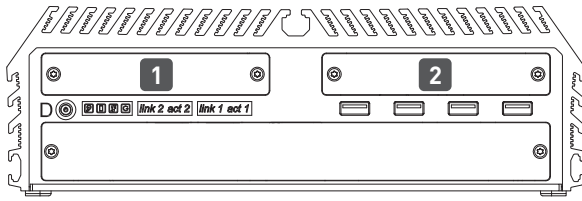

Model No.	Description
MXM-P2000-01	Nvidia Quadro Embedded P2000 MXM Kit with Heatsink and Thermal Pad
MXM-E9174-01	AMD Radeon Embedded E9174 MXM Kit with Heatsink and Thermal Pad

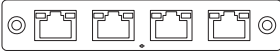
Optional Accessory

Model No.	Description
CB-DP01-R10	Carrier Board Module with 1x MXM 3.1 Interface and 4x DisplayPort Output / 1x Universal Bracket with 4x DP Cutout
CMI-LAN01-R12/UB1312	CMI Module with 4x Intel® I210-IT GbE LAN, RJ45 Port / 1x Universal Bracket with 4x RJ45 Cutout for GM Series
CMI-10GLAN01-R10/UB1328	CMI Module with 2x Intel® X550 10GbE LAN, RJ45 Port / 1x Universal Bracket with 2x RJ45 Cutout for GM Series
CMI-M12LAN01-R12/UB1310	CMI Module with M12 Connector, 4x Intel® GbE LAN / 1x Universal Bracket with 4x M12 Cutout for GM Series
CMI-DIO01/UB1318	CMI Module with 16DIO (8in 8out) / 1x Universal Bracket with DIO Cutout for DX & GM Series
CMI-COM01/UB1303	CMI Module with 2x RS232/422/485 (Support 5V/12V) / 1x Universal Bracket with 2x DB9 Cutout for DX & GM Series
CMI-LAN01-R12/UB1312/CFM-PoE01	CMI Module with 4x Intel® I210-IT GbE LAN, RJ45 Port / 1x Universal Bracket with 4x RJ45 Cutout for GM Series / CFM Module with PoE Control Function, Individual Port 25.5W
CMI-M12LAN01-R12/UB1310/CFM-PoE01	CMI Module with M12 Connector, 4x Intel® GbE LAN / 1x Universal Bracket with 4x M12 Cutout for GM Series / CFM Module with PoE Control Function, Individual Port 25.5W
CFM-IGN01	CFM Module with Power Ignition Sensing Control Function, 12V/24V Selectable
MEC-COM-M212-TDB9/UB1303	Mini-PCIe Module with 2x RS-232 Serial Ports, 1x Thin DB9 Cable / 1x Universal Bracket with 2x DB9 Cutout for DX & GM Series
MEC-COM-M334-TDB9/2xUB1303	Mini-PCIe Module with 4x RS232/422/485 Serial Ports, 2x Thin DB9 Cable / 2x Universal Bracket with 2x DB9 Cutout for DX & GM Series
MEC-LAN-M002-30/UB1311	Mini-PCIe Module with 2x LAN Ports, 2x 30cm cable / 1x Universal Bracket with 2x RJ45 Cutout for DX & GM Series
MEC-USB-M102-15/UB1314	Mini-PCIe Module with 2x USB Ports, 1x 15cm cable / 1x Universal Bracket with 2x USB Cutout for DX & GM Series
FAN-EX102	External Fan Kit with 2x 4pin Terminal Block Plug for GM Series, Support Smart Fan Function
SIDE-GM	GM Series side mount kit
DIN01	DIN-RAIL Mount Kit, KMRH-K175
GST220A24-CIN	Adapter AC/DC 24V 9.2A 220W with 3pin Terminal Block Plug 5.0mm Pitch, with TUBES, level VI

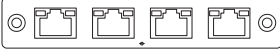
Optional Module Configuration

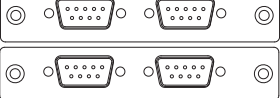

Model No.	Description	1	2	3	4
CB-DP01-R10 	Carrier Board Module with 1x MXM 3.1 Interface and 4x DisplayPort Output / 1x Universal Bracket with 4x DP Cutout	V	-	-	-
CMI-LAN01-R12/UB1312 	CMI Module with 4x Intel® I210-IT GbE LAN, RJ45 Port / 1x Universal Bracket with 4x RJ45 Cutout for GM Series	-	V	-	-
CMI-10GLAN01-R10/UB1328 	CMI Module with 2x Intel® X550 10GbE LAN, RJ45 Port / 1x Universal Bracket with 2x RJ45 Cutout for GM Series	-	V	-	-
CMI-M12LAN01-R12/UB1310 	CMI Module with M12 Connector, 4x Intel® GbE LAN / 1x Universal Bracket with 4x M12 Cutout for GM Series	-	V	-	-
CMI-DIO01/UB1318 	CMI Module with 16DIO (8in 8out) / 1x Universal Bracket with DIO Cutout for DX & GM Series	-	-	V	-
CMI-COM01/UB1303 	CMI Module with 2x RS232/422/485 (Support 5V/12V) / 1x Universal Bracket with 2x DB9 Cutout for DX & GM Series	-	-	V	-
CMI-LAN01-R12/UB1312/CFM-PoE01 	CMI Module with 4x Intel® I210-IT GbE LAN, RJ45 Port / 1x Universal Bracket with 4x RJ45 Cutout for GM Series / CFM Module with PoE Control Function, Individual Port 25.5W	-	V	-	-
CMI-M12LAN01-R12/UB1310/CFM-PoE01 	CMI Module with M12 Connector, 4x Intel® GbE LAN / 1x Universal Bracket with 4x M12 Cutout for GM Series / CFM Module with PoE Control Function, Individual Port 25.5W	-	V	-	-
MEC-COM-M212-TDB9/UB1303 	Mini-PCle Module with 2x RS-232 Serial Ports, 1x Thin DB9 Cable / 1x Universal Bracket with 2x DB9 Cutout for DX & GM Series	-	-	V	V
MEC-COM-M334-TDB9/2xUB1303 	Mini-PCle Module with 4x RS232/422/485 Serial Ports, 2x Thin DB9 Cable / 2x Universal Bracket with 2x DB9 Cutout forDX & GM Series	-	-	V	
MEC-LAN-M002-30/UB1311 	Mini-PCle Module with 2x LAN Ports, 2x 30cm cable / 1x Universal Bracket with 2x RJ45 Cutout for DX & GM Series	-	-	V	-
MEC-USB-M102-15/UB1314 	Mini-PCle Module with 2x USB Ports, 1x 15cm cable / 1x Universal Bracket with 2x USB Cutout for DX & GM Series	-	-	V	-

V : Compatible

Operating Temperature Matrix Table

Model No.	GPU Model	35W CPU	65W CPU	80W CPU
MXM-P2000-01	Nvidia Quadro Embedded P2000 (58W)	-40°C - 55°C	-40°C - 55°C	-40°C - 50°C
MXM-E9174-01	AMD Radeon Embedded E9174 (50W)	-40°C - 50°C	-40°C - 50°C	-40°C - 50°C

- * External Fan Kit - FAN-EX102 is required for above configurations.
- * PassMark BurnInTest: 100% CPU, 2D Graphics (without thermal throttling)
- * Furmark: 1920x 1080, 8x MSAA (without thermal throttling)