

DS-1400 Series

BTL-S/14/13/12th Generation Intel Core Series Processors, High Performance & PCIe Expandable Rugged Embedded Computer, Supporting up to 2x PCI/PCIe Expansion Card



DS-1402

High Performance | Highly Expandable

DS-1402, BTL-S / 14 / 13 / 12th Gen. Intel Core Processor Rugged Embedded Computer



Overview

[CONTACT](#)

The DS-1400 Series is high-performance, expandable, and rugged embedded computer, boasting outstanding performance as well as rich industrial I/O interfaces and robust functionalities. To meet various application needs, it has dual PCI/PCIe expansion capability and it can also flexibly expand the required I/O and specific functions through Cincoze's unique CMI, CFM, and MEC modules. Moreover, the DS-1400 Series has passed multiple international certifications, ensuring stable and reliable performance in diverse harsh environments. It is an ideal choice for manufacturing and railway applications.

Key Features

- Intel® BTL-S/14/13/12th Gen. Bartlett Lake-S / Raptor Lake-S Refresh / Raptor Lake-S / Alder Lake-S Platform (max 65 W TDP)
- 2x DDR5 SO-DIMM Sockets, Supports ECC/non ECC type Memory, Up to 5600MHz, 96GB
- 2x GbE LAN and optional 2x 10GbE LAN
- 2x 2.5" SATA storage, 3x mSATA sockets, 1x M.2 key M for NVMe SSD
- Up to 2x PCI/PCIe expansion slots, supports GPU card up to 130W
- Optional CMI modules for I/O expansion
- Optional CFM modules for ignition sensing & PoE
- Wide operating temperature -40°C to 70°C
- MIL-STD-810G military standard and EN50155 (EN 50121-3-2 only)
- Safety Standard: UL, cUL, CB, IEC, EN 62368-1
- Support Intel® OpenVINO™ Dev Kit
- Intel® ESDQ (Edge Software Device Qualification) Certified: the Edge Insights for AMR software package

Certifications



Rapid Processing and Inference

The DS-1400 Series supports Intel® BTL-S/14/13/12th gen (Bartlett Lake-S/Raptor Lake-S Refresh/Raptor Lake-S/Alder Lake-S) processors based on the Intel 7 process, with up to 24 cores (8P + 16E) and 32 threads, delivering more than 2.5x the speed of Comet Lake-S platform. The Intel® Xe architecture of the UHD 770 graphics chip boosts GPU image classification inference performance to 2.8x the speed of Comet Lake-S, providing the processing performance needed for AI and edge computing.

CPU Performance

Raptor Lake-S Refresh **250%** ↗

Comet Lake-S



Raptor Lake-S Refresh

GPU Image Classification Inference Performance

UHD Graphics 770 **281%** ↗

UHD Graphics 630



Industrial I/O and Modular Expansion

The DS-1400 Series offers a vast array of industrial-focused I/O including up to 2x GbE LAN, 6x USB 3.2, and 2x USB 2.0, 2x RS232/422/485, 2x 2.5" SATA, 3x mSATA, 1x M.2 key M for NVMe SSD, 2x SIM card slots, 3x full-size Mini-PCIe and quad independent displays (DisplayPort, HDMI, VGA). It also features modular expansion through Cincoze's CMI/CFM modules, adding additional I/O or other functionality such as high-speed 10GbE LAN, PoE, and IGN (power ignition sensing).

PCI/PCIe Add-on Cards

The DS-1400 Series accommodates up to dual PCI/PCIe expansion slots. It can support a maximum of one 130W add-on card with dimensions of 111 x 235 mm. This flexible slot allows integration of I/O, GPU, image capture, data acquisition, and motion control cards to suit specific application needs.



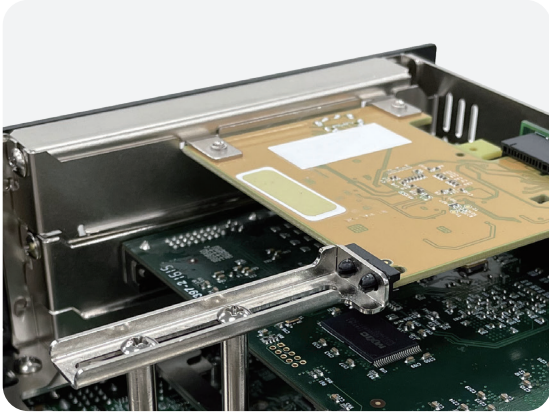

Adjustable PCIe Card Retainer

A patented adjustable PCIe card retainer can securely fasten add-on cards. This unique design effectively prevents the cards from loosening due to vibrations in high-vibration environments, ensuring the stable operation of the system.

Patent No. I773359

Robust and Reliable

The DS-1400 Series is built tough, reflected in its industrial-grade protection design and industry certifications in different fields. In addition to features such as wide temperature (-40 - 70°C), wide voltage input (9 - 48 VDC), overvoltage, overcurrent, and ESD protection, it also complies with the US military shock vibration standard MIL-STD-810G. Product safety and reliability are further ensured with internationally recognized UL 62368-1 safety certification. For more secure railway computing, it also passes the EMC EN 50121-3-2 standard in EN 50155.

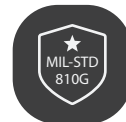

Specifications

Model Name	DS-1400	DS-1401	DS-1402
System			
Processor	<ul style="list-style-type: none"> ▪ Bartlett Lake-S Intel® Core Series 2 P-Core Only CPU <ul style="list-style-type: none"> - Intel Core™ Processor 9 273PE 12 Cores Up to 5.7 GHz, TDP 65 W - Intel Core™ Processor 9 273PTE 12 Cores Up to 5.5 GHz, TDP 45 W - Intel Core™ Processor 7 253PE 10 Cores Up to 5.5 GHz, TDP 65 W - Intel Core™ Processor 7 253PTE 10 Cores Up to 5.4 GHz, TDP 45 W - Intel Core™ Processor 5 223PE 8 Cores Up to 5.4 GHz, TDP 65 W - Intel Core™ Processor 5 223PTE 8 Cores Up to 5.4 GHz, TDP 45 W - Intel Core™ Processor 5 213PE 8 Cores Up to 5.2 GHz, TDP 65 W - Intel Core™ Processor 5 213PTE 8 Cores Up to 5.2 GHz, TDP 45 W ▪ Bartlett Lake-S Intel® Core Series 2 Hybrid CPU <ul style="list-style-type: none"> - Intel Core™ Processor 7 251E 24 Cores Up to 5.6 GHz, TDP 65 W - Intel Core™ Processor 7 251TE 24 Cores Up to 5.4 GHz, TDP 45 W - Intel Core™ Processor 5 221E 14 Cores Up to 5.2 GHz, TDP 65 W - Intel Core™ Processor 5 221TE 14 Cores Up to 5.0 GHz, TDP 45 W - Intel Core™ Processor 5 211E 10 Cores Up to 4.9 GHz, TDP 65 W - Intel Core™ Processor 5 211TE 10 Cores Up to 4.8 GHz, TDP 45 W - Intel Core™ Processor 3 201E 4 Cores Up to 4.8 GHz, TDP 60 W - Intel Core™ Processor 3 201TE 4 Cores Up to 4.6 GHz, TDP 45 W ▪ 14th Generation Intel® Raptor Lake-S Refresh Series P-Core Only CPU: <ul style="list-style-type: none"> - Intel® Core™ i9-14901E 8 Cores Up to 5.6 GHz, TDP 65W - Intel® Core™ i7-14701E 8 Cores Up to 5.4 GHz, TDP 65W - Intel® Core™ i5-14501E 6 Cores Up to 5.2 GHz, TDP 65W - Intel® Core™ i5-14401E 6 Cores Up to 4.7 GHz, TDP 65W - Intel® Core™ i3-14100 4 Cores Up to 4.7 GHz, TDP 60W - Intel® Core™ i9-14901TE 8 Cores Up to 5.5 GHz, TDP 45W - Intel® Core™ i7-14701TE 8 Cores Up to 5.2 GHz, TDP 45W - Intel® Core™ i5-14501TE 6 Cores Up to 5.1 GHz, TDP 45W - Intel® Core™ i5-14401TE 6 Cores Up to 4.5 GHz, TDP 45W - Intel® Core™ i3-14100T 4 Cores Up to 4.4 GHz, TDP 35W - Intel® Processor 300 2 Cores Up to 3.9 GHz, TDP 46W - Intel® Processor 300T 2 Cores Up to 3.4 GHz, TDP 35W ▪ 14th Generation Intel® Raptor Lake-S Refresh Series Hybrid CPU: <ul style="list-style-type: none"> - Intel® Core™ i9-14900 24 Cores Up to 5.8 GHz, TDP 65W - Intel® Core™ i7-14700 20 Cores Up to 5.4 GHz, TDP 65W - Intel® Core™ i5-14500 14 Cores Up to 5.0 GHz, TDP 65W - Intel® Core™ i5-14400 10 Cores Up to 4.7 GHz, TDP 65W - Intel® Core™ i9-14900T 24 Cores Up to 5.5 GHz, TDP 35W - Intel® Core™ i7-14700T 20 Cores Up to 5.2 GHz, TDP 35W - Intel® Core™ i5-14500T 14 Cores Up to 4.8 GHz, TDP 35W - Intel® Core™ i5-14400T 10 Cores Up to 4.5 GHz, TDP 35W ▪ 13th Generation Intel® Raptor Lake-S Series P-Core Only CPU: <ul style="list-style-type: none"> - Intel® Core™ i3-13100E 4 Cores Up to 4.4 GHz, TDP 60W - Intel® Core™ i3-13100TE 4 Cores Up to 4.1 GHz, TDP 35W ▪ 13th Generation Intel® Raptor Lake-S Series Hybrid CPU: <ul style="list-style-type: none"> - Intel® Core™ i9-13900E 24 Cores Up to 5.2 GHz, TDP 65W - Intel® Core™ i7-13700E 16 Cores Up to 5.1 GHz, TDP 65W - Intel® Core™ i5-13500E 14 Cores Up to 4.6 GHz, TDP 65W - Intel® Core™ i5-13400E 10 Cores Up to 4.6 GHz, TDP 65W - Intel® Core™ i9-13900TE 24 Cores Up to 5.0 GHz, TDP 35W - Intel® Core™ i7-13700TE 16 Cores Up to 4.8 GHz, TDP 35W - Intel® Core™ i5-13500TE 14 Cores Up to 4.5 GHz, TDP 35W ▪ 12th Generation Intel® Alder Lake-S Series P-Core Only CPU: <ul style="list-style-type: none"> - Intel® Pentium® G7400E 2 Cores Up to 3.6 GHz, TDP 46W - Intel® Pentium® G7400TE 2 Cores Up to 3.0 GHz, TDP 35W - Intel® Celeron® G6900E 2 Cores Up to 3.0 GHz, TDP 46W - Intel® Celeron® G6900TE 2 Cores Up to 2.4 GHz, TDP 35W ▪ 12th Generation Intel® Alder Lake-S Series Hybrid CPU: <ul style="list-style-type: none"> - Intel® Core™ i9-12900E 16 Cores Up to 5 GHz, TDP 65W - Intel® Core™ i7-12700E 12 Cores Up to 4.8 GHz, TDP 65W - Intel® Core™ i5-12500E 6 Cores Up to 4.5 GHz, TDP 65W - Intel® Core™ i3-12100E 4 Cores Up to 4.2 GHz, TDP 60W - Intel® Core™ i9-12900TE 16 Cores Up to 4.8 GHz, TDP 35W - Intel® Core™ i7-12700TE 12 Cores Up to 4.7 GHz, TDP 35W - Intel® Core™ i5-12500TE 6 Cores Up to 4.3 GHz, TDP 35W - Intel® Core™ i3-12100TE 4 Cores Up to 4.0 GHz, TDP 35W 		

Chipset	• Intel R680E Chipset		
Memory	<ul style="list-style-type: none"> • 2x DDR5 SO-DIMM sockets, support Un-buffered and ECC Type memory, up to 96GB. - Core™ i9/i7: Support 5600/4800 MHz with Single Rank memory and 5200/4800 MHz with Dual Rank memory. - Core™ i5/i3/Pentium®/Celeron®/Intel® Processor: Support 4800 MHz. 		
BIOS	• AMI BIOS		
Graphics			
Graphics Engine	<ul style="list-style-type: none"> • Integrated Intel® UHD Graphics 770: Core™ i9/i7/i5 • Integrated Intel® UHD Graphics 730: Core™ i3 • Integrated Intel® UHD Graphics 710: Pentium®/Celeron® 		
Maximum Display Output	• Supports Quad Independent Display		
VGA	• 1x VGA Connector : 1920 x 1080@60Hz		
DP	<ul style="list-style-type: none"> • 2x DP Connector : 4096 x 2304@60Hz * Verified maximum DP resolution: 3840x2160 @60Hz 		
HDMI	<ul style="list-style-type: none"> • 1x HDMI Connector : 4096x2160@30Hz * Verified maximum resolution: 3840x2160 @30Hz 		
Audio			
Audio Codec	• Realtek® ALC888, High Definition Audio		
Line-out	• 1x Line-out, Phone Jack 3.5mm		
Mic-in	• 1x Mic-in, Phone Jack 3.5mm		
I/O			
LAN	<ul style="list-style-type: none"> • 2x GbE LAN, RJ45 - GbE1: Intel® I219 - GbE2: Intel® I210 		
COM	• 2x RS-232/422/485 with Auto Flow Control (Supports 5V/12V), DB9		
USB	<ul style="list-style-type: none"> • 2 x USB 3.2 Gen2x1 (10Gbps), Type A • 4 x USB 3.2 Gen1x1 (5Gbps), Type A • 2 x USB 2.0 (480Mbps), Type A 		
PS/2	• 1 x PS/2, 6 Pin Mini-DIN Female Connector		
Storage			
SSD/HDD	<ul style="list-style-type: none"> • 1x 2.5" Front Accessible SATA HDD/SSD Bay Supporting Hot Swap Function (SATA 3.0) • 1x 2.5" Internal SATA HDD/SSD Bay (SATA 3.0) 		
mSATA	• 3x mSATA Socket (SATA 3.0, shared by Mini-PCIe socket)		
M.2 SSD	• 1x M.2 Key M Type 2280 Socket, Support PCIe Gen3 x4 NVMe SSD or SATA SSD (SATA 3.0)		
RAID	• Support RAID 0/1/5/10		
Expansion			
PCI Express		<ul style="list-style-type: none"> • 1x PCI/PCIe Expansion Slot with Optional Riser Card * Supports maximum dimensions of add-on card (L x H) : 235 x 124 mm * Supports GPU card up to 75W 	<ul style="list-style-type: none"> • 2x PCI/PCIe Expansion Slot with Optional Riser Card * Supports maximum dimensions of add-on card (L x H) : 235 x 124 mm * Supports GPU card up to 130W
Mini PCI Express	<ul style="list-style-type: none"> • 2x Full-size Mini PCIe Socket (mPCIe / USB 2.0 / mSATA), Support Storage/Add-on Card Expansion • 1x Full-size Mini PCIe Socket (mPCIe / USB 3.2 / mSATA), Support 5G/GNSS/Storage/Add-on Card Expansion 		
SIM Socket	• 2x SIM Socket		
CMI (Combined Multiple I/O) Interface	<ul style="list-style-type: none"> • 2x High Speed CMI Interface for optional CMI Module Expansion • 2x Low Speed CMI Interface for optional CMI Module Expansion 		
CFM (Control Function Module) Interface	• 1x CFM IGN Interface for optional CFM-IGN Module Expansion		

Other Function			
External FAN Connector	• 1x External FAN Connector, 4-pin Terminal Block (Support Smart Fan by BIOS)		
Power Ignition Sensing	• Support Power Ignition Sensing Function with Delay Time Management and Selectable 12V/24V (With Optional CFM Module)		
Clear CMOS Switch	• 1x Clear CMOS Switch		
Reset Button	• 1x Reset Button		
Instant Reboot	• Support 0.2sec Instant Reboot Technology		
Watchdog Timer	• Software Programmable Supports 256 Levels System Reset		
Power			
Power Button	• 1x ATX Power On/Off Button		
Power Mode Switch	• 1x AT/ATX Mode Switch		
Power Input	• 9 - 48VDC, 3-pin Terminal Block		
Remote Power On/Off	• 1x Remote Power On/Off, 2-pin Terminal Block		
Remote Power LED	• 1x Remote Power LED, 2-pin Terminal Block		
Max. Power Consumption	<ul style="list-style-type: none"> • 35W CPU: 206.93W • 65W CPU: 250.56W - Test conducted with CPU, 1x RAM, and 1x storage - 100% load during burn-in testing 		
Inrush Current (Peak)	<ul style="list-style-type: none"> • 35W CPU: 6.283 A@24V • 65W CPU: 6.655 A@24V 		
Physical			
Reverse Power Input Protection	• Yes		
Over Voltage Protection	<ul style="list-style-type: none"> • Protection Range: 51~58V • Protection Type: shut down operating voltage, re-power on at the preset level to recover 		
Over Current Protection	• 15A		
CMOS Battery Backup	• SuperCap Integrated for CMOS Battery Maintenance-free Operation		
MTBF	<ul style="list-style-type: none"> • 371,274 Hours - Database: Telcordia SR-332 Issue3, Method 1, Case 3 		
Reliability & Protection			
Dimension(W x D x H)	• 227 x 261 x 88 mm	• 227 x 261 x 108 mm	• 227 x 261 x 128 mm
Weight Information	• 4.5 kg	• 5.02 kg	• 5.44 kg
Mechanical Construction	• Extruded Aluminum with Heavy Duty Metal		
Mounting	• Wall		
Physical Design	<ul style="list-style-type: none"> • Fanless Design • Cableless Design • Jumper-less Design • Unibody Design 		
Operating System			
Windows	• Windows®11, Windows®10		
Linux	• Ubuntu Desktop 22.04 LTS		

Environment	
Operating Temperature	<ul style="list-style-type: none"> ▪ 35W TDP Processor: -40°C to 70°C (-40°F to 158°F) ▪ 45W TDP Processor: -40°C to 60°C (-40°F to 140°F) (With External Fan Kit) ▪ 65W TDP Processor: -40°C to 50°C (-40°F to 122°F) (With External Fan Kit) - With extended temperature peripherals; Ambient with air flow - According to IEC60068-2-1, IEC60068-2-2, IEC60068-2-14
Storage Temperature	<ul style="list-style-type: none"> ▪ -40°C to 85°C (-40°F to 185°F)
Relative Humidity	<ul style="list-style-type: none"> ▪ 95%RH @ 70°C (non-Condensing)
Shock	<ul style="list-style-type: none"> ▪ MIL-STD-810G
Vibration	<ul style="list-style-type: none"> ▪ MIL-STD-810G
EMC	<ul style="list-style-type: none"> ▪ CE, UKCA, FCC, ICES-003 Class A ▪ EN 50155 (EN 50121-3-2 Only)
EMI	<ul style="list-style-type: none"> ▪ CISPR 32 Conducted & Radiated: Class A ▪ EN/BS EN 50121-3-2 Conducted & Radiated: Class A ▪ EN/BS EN IEC 61000-3-2 Harmonic current emissions: Class A ▪ EN/BS EN61000-3-3 Voltage fluctuations & flicker ▪ FCC 47 CFR Part 15B, ICES-003 Conducted & Radiated: Class A
EMS	<ul style="list-style-type: none"> ▪ EN/IEC 61000-4-2 ESD: Contact: 6 kV; Air: 8 kV ▪ EN/IEC 61000-4-3 RS: 80 MHz to 1000 MHz: 20 V/m ▪ EN/IEC 61000-4-4 EFT: AC Power: 2 kV; Signal: 2 kV ▪ EN/IEC 61000-4-5 Surges: AC Power: 2 kV ▪ EN/IEC 61000-4-6 CS: 10V ▪ EN/IEC 61000-4-8 PFMF: 50 Hz, 1A/m ▪ EN/IEC 61000-4-11 Voltage Dips & Voltage Interruptions: 0.5 cycles at 50 Hz
Safety	<ul style="list-style-type: none"> ▪ UL, cUL, CB, IEC, EN 62368-1

DS-1400 External Layout

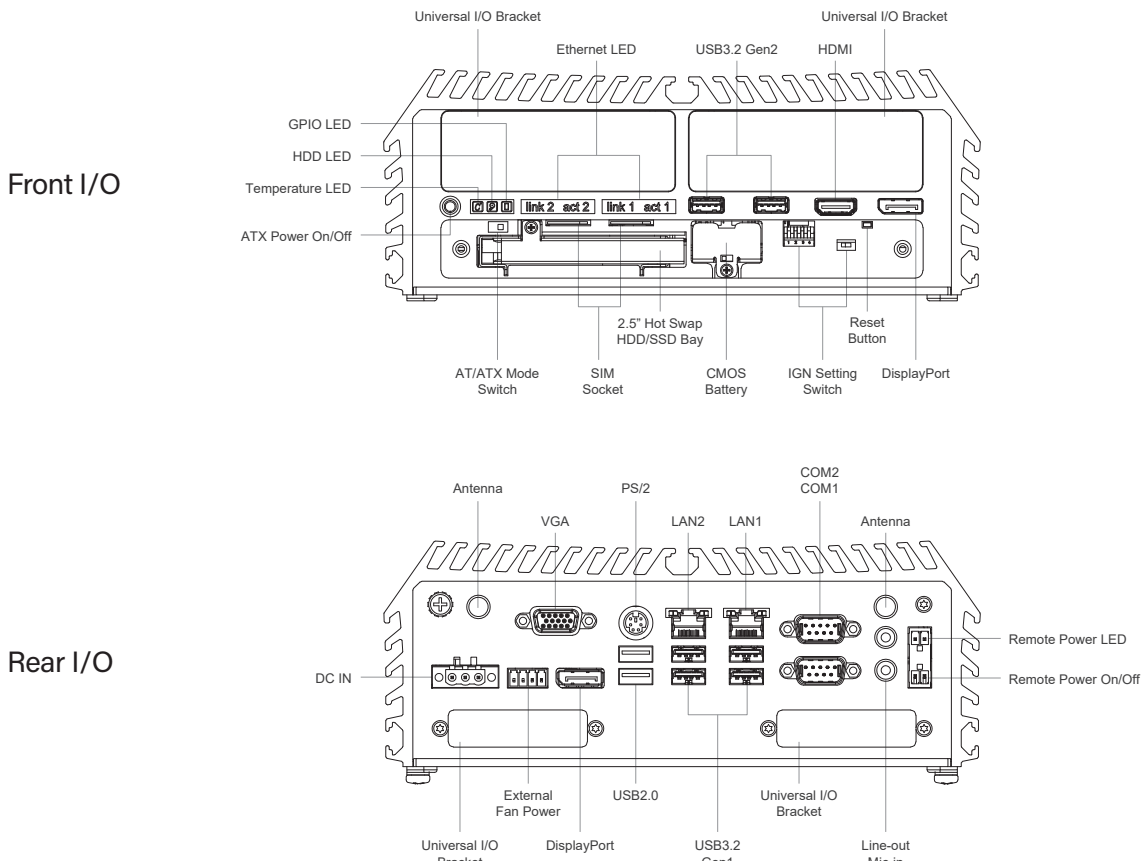

DS-1401 External Layout

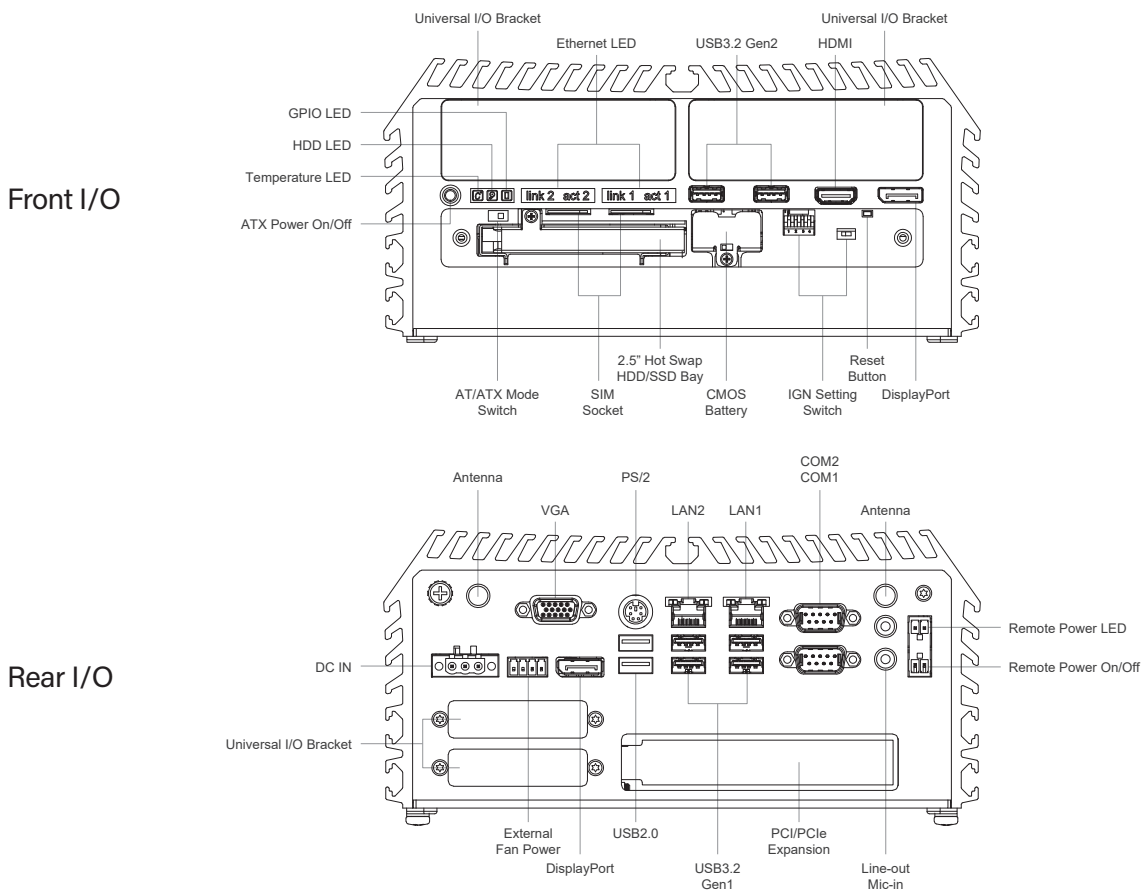

DS-1402 External Layout

Front I/O

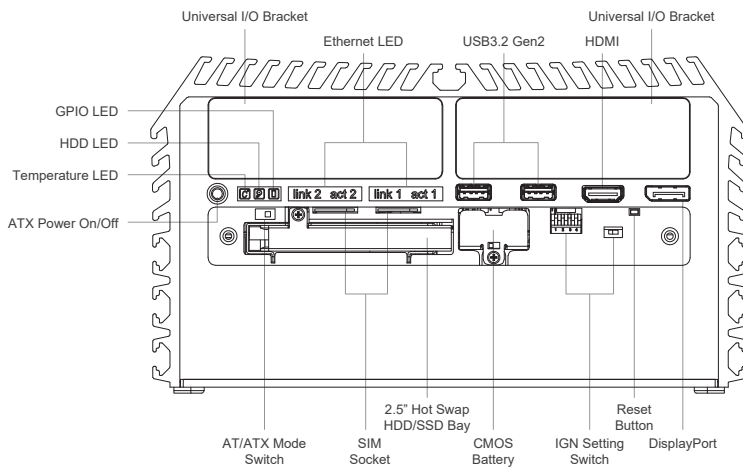

Rear I/O

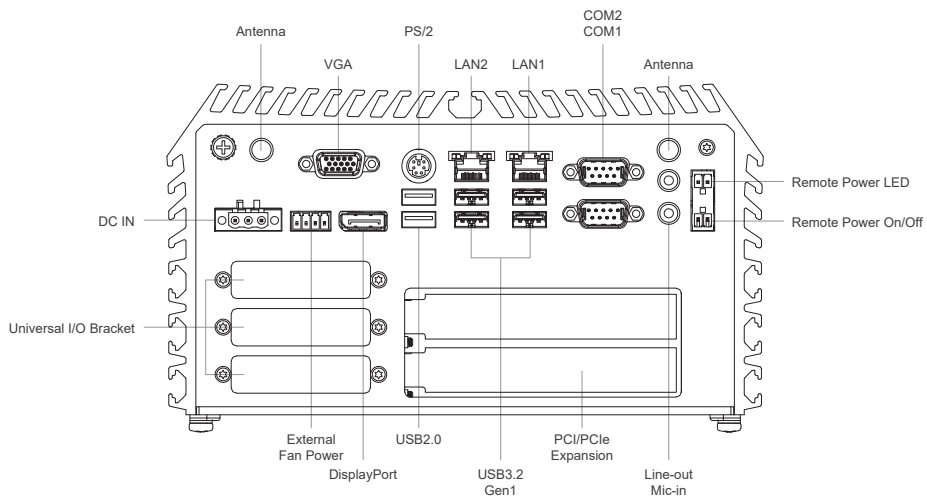

DS-1402 Dimensions

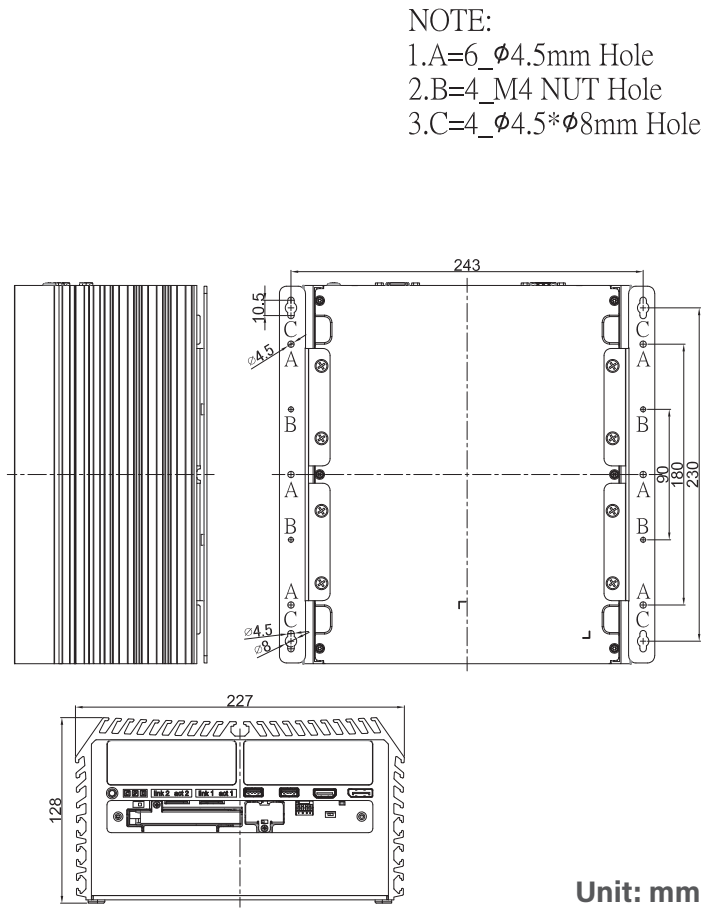
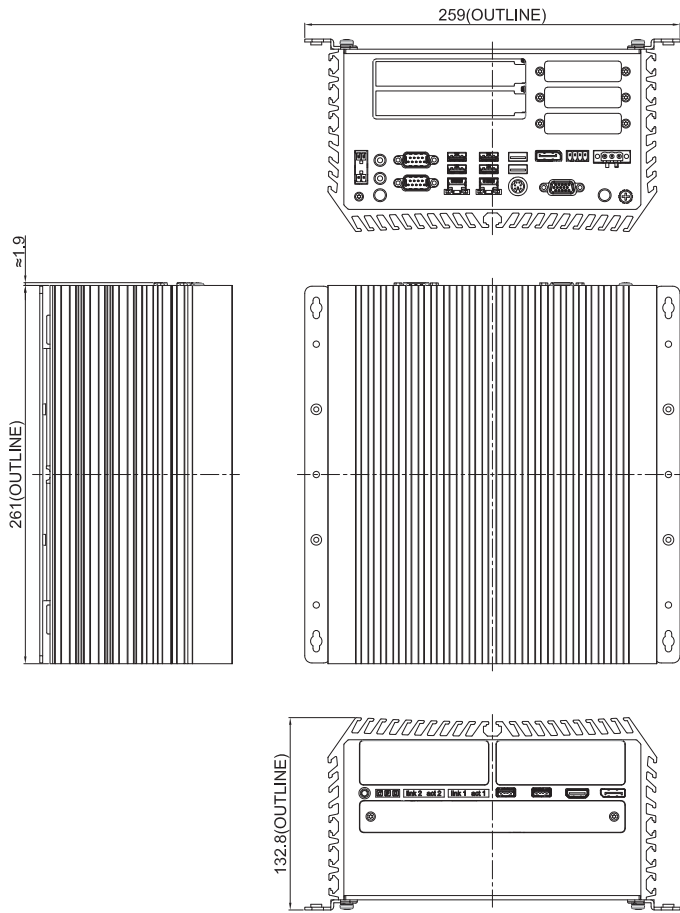

NOTE:
 1.A=6_φ4.5mm Hole
 2.B=4_M4 NUT Hole
 3.C=4_φ4.5*φ8mm Hole

Unit: mm

Ordering Information

Available Models

Model No.	Description
DS-1400-R10	BTL-S/14/13/12th Generation Intel Core Series Processors, High Performance and PCIe Expandable Rugged Embedded Computer
DS-1401-R10	BTL-S/14/13/12th Generation Intel Core Series Processors, High Performance and PCIe Expandable Rugged Embedded Computer, Supporting 1x PCI/PCIe Expansion Card
DS-1402-R10	BTL-S/14/13/12th Generation Intel Core Series Processors, High Performance and PCIe Expandable Rugged Embedded Computer, Supporting 2x PCI/PCIe Expansion Cards

Package Checklist

• DS-1400 Series Embedded System x1	• Heatsink Pack x1
• Wall Mounting Kit x 1	• Screw Pack x1
• Power Terminal Block Connector x 1	• Remote Function Terminal Block Connector x 2
• Fan Terminal Block Connector x 1	

Optional Modules and Accessories

Model No.	Description
CMI-LAN01-R12	CMI Module with 4x RJ45 Intel I210 GbE LAN Ports
CMI-M12LAN01-R12	CMI Module with 4x M12 Intel I210 GbE LAN Ports
CMI-XM12LAN01-R10	CMI Module with M12 X-Coded Connector, 4x Intel I210 GbE LAN Ports
CMI-2P5GLAN03-R10	CMI Module with 4x Intel 2.5GbE LAN, RJ45 Port
CMI-10GLAN03-R10	CMI Module with 2x Intel X550 10GbE LAN, RJ45 Port
CMI-10GXM12LAN03-R10	CMI Module with 2x Intel 10GbE LAN, M12 X-Coded Connector
CMI-CAN01-R10	CMI Module with 2x CAN FD Ports
CMI-COM02	CMI Module with 4x RS232/422/485 Serial Ports
CMI-ICOM01	CMI Module with 4x Electrical Isolated RS-232 Serial Ports
CMI-DIO02	CMI Module with 16x Optical Isolated DIO (8 in/8 out)
MEC-LAN-M102-30	Mini-PCIe Module with 2x LAN Ports, 2x 30cm cable
MEC-USB-M102-30	Mini-PCIe Module with 2x USB 3.2 Gen1 Ports, 1x 30cm cable
MEC-COM-M212-DB9	Mini-PCIe Module with 2x RS-232 Serial Ports, 1x Standard DB9 Cable
UB1004	Universal Bracket with 4x DB9 Cutout
UB1010	Universal Bracket with 4x M12 Cutout
UB1012	Universal Bracket with 4x RJ45 Cutout
UB1018	Universal Bracket with DIO Cutout
UB1028	Universal Bracket with 2x RJ45 Cutout
UB1030-R10	Universal Bracket with 4x M12 X-Coded Cutout
UB1032-R10	Universal Bracket with 3x Antenna Cutout

UB1037-R10	Universal Bracket with 2x M12 X-coded Cutout
UB1038-R10	Universal Bracket with 2x DB9 and 1x Switch Cutout for CMI-CAN Expansion
UB0303	2x Universal Bracket each with 1x DB9 Cutout
UB0311	Universal Bracket with 2x RJ45 Cutout
UB0314	Universal Bracket with 2x USB Cutout
UB0331-R10	Universal Bracket with 2x Antenna Cutout
CFM-PoE03	CFM Module with PoE Control Function, Individual Port 25.5W
CFM-IGN101	CFM Module with Power Ignition Sensing Control Function, 12V/24V Selectable
FAN-EX101	External Fan with 4pin Terminal Block Plug, Mounting Bracket, Support smart fan
FAN-UB100	Internal Exhaust Fan with 4pin Connector
FAN-UB101	Internal Intake Fan with 4pin Connector
GST220A24-CIN	Adapter AC/DC 24V 9.2A 220W with 3pin Terminal Block Plug and Tubes, Level VI
GST360A24-CIN	Adapter AC/DC 24V 15A 360W with 3pin Terminal Block Plug and Tubes, Level VI
RSD-200D-24	Railway Single Output DC-DC Converter 200W / DC 24V
Power Cable	1M Power Cable with 3-Pin Terminal Block Plug, Stripped and Tinned End with Tube
RC-E16-01	Riser Card with 1 x PCIe16 Slot
RC-PI-01	Riser Card with 1 x PCI Slot
RC-E8E8-R10	Riser Card with 2 x PCIe8 Slots
RC-E16E1-01	Riser Card with 1x PCIe16, 1x PCIe1 slots, supports GPU card up to 75W
RC-E16E1-02-R10	Riser Card with 1x PCIe16, 1x PCIe1 slots, and auxiliary power connector, supports GPU card up to 130W
RC-E16PI-01	Riser Card with 1x PCIe16 and 1x PCI Slots (PCIe x16 Slot Supports Single Deck Add-on Card)
RC-PIPI-01	Riser Card with 2x PCI Slots

Optional Module Configuration - Front side

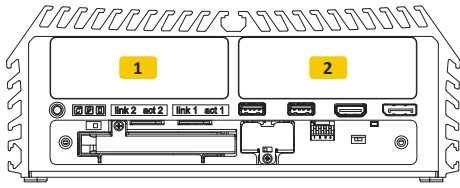



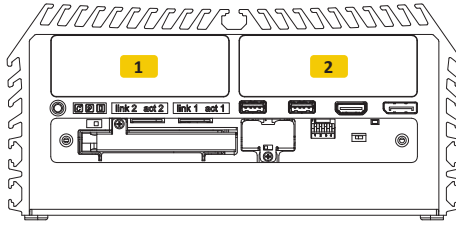



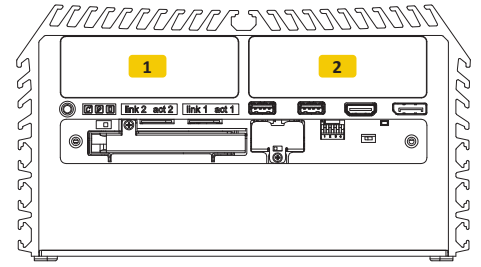



DS-1400



DS-1401



DS-1402

Model No.	Description	1	2
CMI-LAN01-R12/UB1012 	CMI Module with 4x Intel I210 GbE LAN, RJ45 Port / 1x Universal Bracket with 4x RJ45 Cutout	V	V
CMI-M12LAN01-R12/UB1010 	CMI Module with M12 Connector, 4x Intel GbE LAN / 1x Universal Bracket with 4x M12 Cutout	V	V
CMI-XM12LAN01-R10/UB1030-R10 	CMI Module with M12 X-Coded Connector, 4x Intel I210 GbE LAN Ports / Universal Bracket with 4x M12 X-Coded Cutout	V	V
CMI-2P5GLAN03-R10/UB1012 	CMI Module with 4x Intel 2.5GbE LAN, RJ45 Port / 1x Universal Bracket with 4x RJ45 Cutout	V	-
CMI-10GLAN03-R10/UB1028 	CMI Module with 2x Intel X550 10GbE LAN, RJ45 Port / 1x Universal Bracket with 2x RJ45 Cutout	V	-
CMI-10GXM12LAN03-R10/UB1037-R10 	CMI Module with 2x Intel 10GbE LAN, M12 X-Coded Connector / Universal Bracket with 2x M12 X-coded Cutout	V	-
CMI-CAN01-R10/UB1038-R10 	CMI Module with 2x CAN FD Ports / Universal Bracket with 2x DB9 and 1x Switch Cutout for CMI-CAN Expansion	V	V
CMI-COM02/UB1004 	CMI Module with 4x RS232/422/485 Ports (Support 5V/12V) / 1x Universal Bracket with 4x DB9 Cutout	V	
CMI-ICOM01/UB1004 	CMI Module with 4 x isolated RS232/422/485/ 1x Universal Bracket with 4x DB9 Cutout	V	
CMI-DIO02/UB1018 	CMI Module with 16DIO (8in 8out) / 1x Universal Bracket with DIO Cutout	V	V
UB1032-R10 	Universal Bracket with 3x Antenna Cutout	V	V

Remark:

Maximum one CMI-COM02 or CMI-ICOM01 module can be installed in this system.

V : Compatible

Optional Module Configuration - Rear side

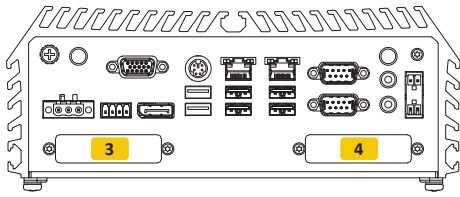



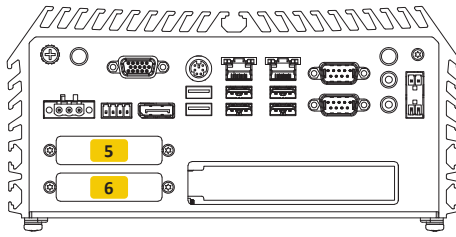

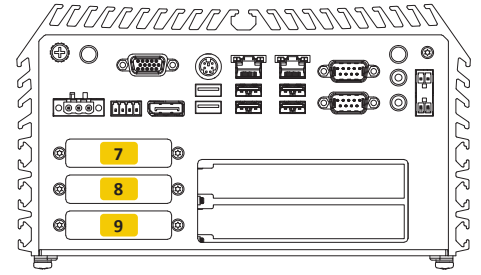

DS-1400



DS-1401



DS-1402

Model No.	Description	DS-1400		DS-1401		DS-1402		
		3	4	5	6	7	8	9
MEC-LAN-M102-30/UB0311 	Mini-PCIe Module with 2x LAN Ports, 2x 30cm cable / 1x Universal Bracket with 2x RJ45 Cutout	V	V	V	V	-	V	V
MEC-USB-M102-30/UB0314 	Mini-PCIe Module with 2x USB 3.2 Gen1 Ports, 1x 30cm cable, 1x Universal Bracket with 2x USB Cutout	V	-	V	V	-	V	V
MEC-COM-M212-DB9/UB0303  	Mini-PCIe Module with 2x RS-232 Ports, 1x Standard DB9 Cable / 2x Universal Bracket each with 1x DB9 Cutout		V		V	-		V
UB0331-R10 	Universal Bracket with 2x Antenna Cutout	V	V	V	V	V	V	V
FAN-UB100 	Internal Exhaust Fan with 4pin Connector	-	-	-	-		V	
FAN-UB101 	Internal Intake Fan with 4pin Connector	-	-	-	-		V	

Remark:
Maximum one CMI-COM02 or CMI-ICOM01 module can be installed in this system.

V : Compatible

Riser Card Configuration

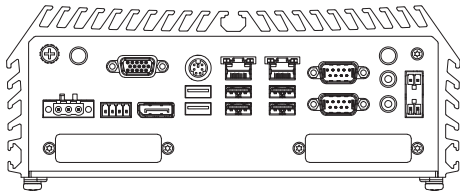



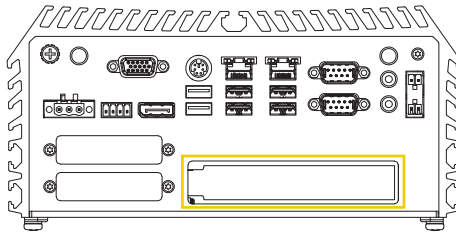

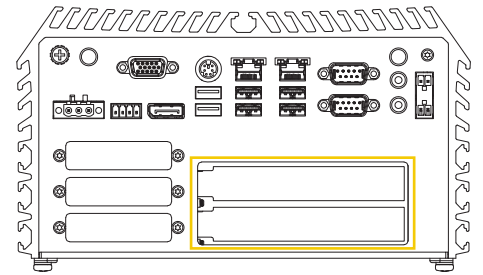

DS-1400



DS-1401



DS-1402

Model No.	Description	DS-1400	DS-1401	DS-1402
 RC-E16-01 Riser Card with 1 x PCIe16 Slot	-	V	-	
 RC-PI-01 Riser Card with 1 x PCI Slot	-	V	-	
 RC-E8E8-R10 Riser Card with 2 x PCIe8 Slots	-	-	V	
 RC-E16E1-01 Riser Card with 1x PCIe16, 1x PCIe1 slots, supports GPU card up to 75W	-	-	V	
 RC-E16E1-02-R10 Riser Card with 1x PCIe16, 1x PCIe1 slots, and auxiliary power connector, supports GPU card up to 130W	-	-	V	
 RC-E16PI-01 Riser Card with 1x PCIe16 and 1x PCI Slots (PCIe x16 Slot Supports Single Deck Add-on Card)	-	-	V	
 RC-PIPI-01 Riser Card with 2x PCI Slots	-	-	V	

Remark:
Maximum one CMI-COM02 or CMI-ICOM01 module can be installed in this system.

V : Compatible

Compatible GPU List

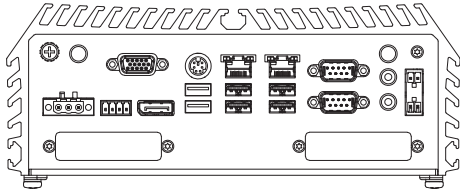

DS-1400

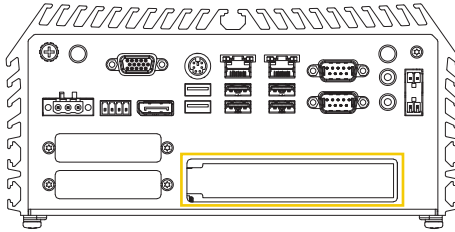

DS-1401

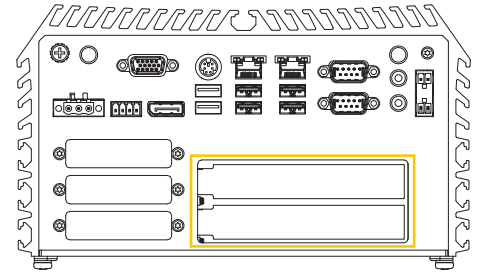

DS-1402

Model	Architecture	Dimesion (L x H mm)	Slot	Power Consumption	DS-1400	DS-1401	DS-1402
RTX PRO 4000 SFF Blackwell	Blackwell	167.6 x 68.6	Dual Slot	70W	-	-	v
RTX PRO 2000 Blackwell	Blackwell	167.6 x 68.6	Dual Slot	70W	-	-	v
RTX A2000 RTX A2000 12GB	Ampere	167.6 x 68.6	Dual Slot	70W	-	-	v
RTX A1000	Ampere	162.6 x 68.6	Single Slot	50W	-	v	v
RTX A400	Ampere	162.6 x 68.6	Single Slot	50W	-	v	v
T1000 T1000 8GB	Turing	155.9 x 68.9	Single Slot	50W	-	v	v
T600	Turing	155.9 x 68.9	Single Slot	40W	-	v	v
T400 T400 4GB	Turing	155.9 x 68.9	Single Slot	30W	-	v	v